

500

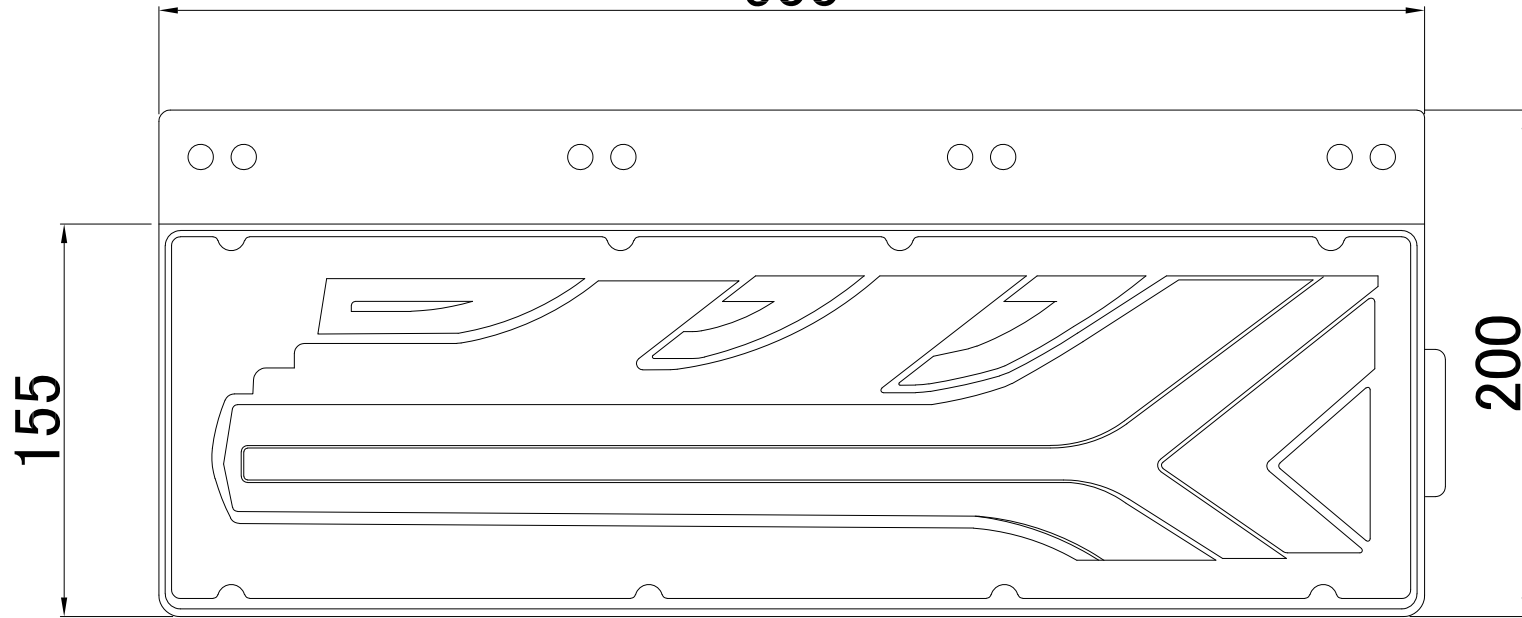

148.9

